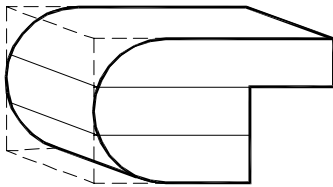
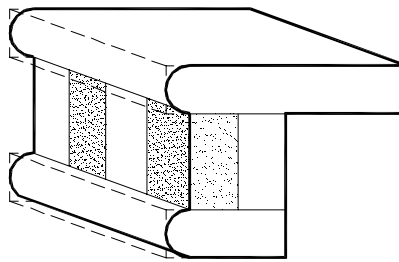

EDGE PROFILES

The drawings below are provided to demonstrate typical construction techniques as guidelines for your designs. They represent only the most common profiles. The design flexibility of Avonite allows virtually unlimited possibilities.

All technical drawings are available for download at www.avonite.com where you can choose from either .dwg or .pdf formats.

1 1/2" (38mm) Bullnose

Double Bullnose
with Checkered Inlay

3" (76mm) Bullnose

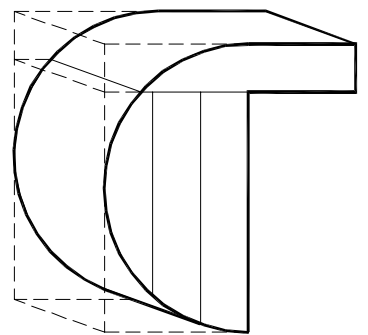

Wood or Laminate Inlay

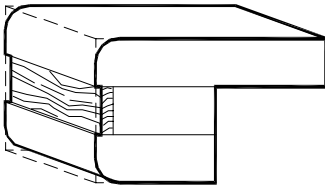

Roundover/Color Accent

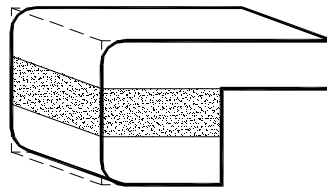

45° Beveled

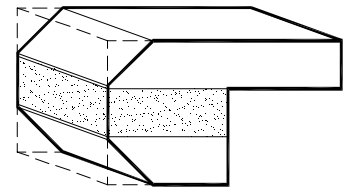

Roundover

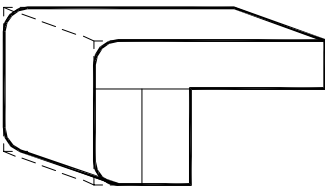

Cove Backsplash

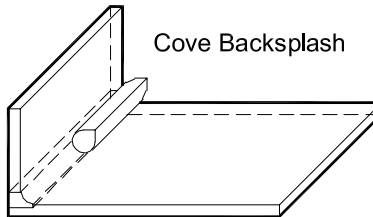

No Drip Edge

